



www.oriason.fr

2018



— Pergolas ♦ Carports ♦ Brise-soleil —







*Profitez de vos extérieurs tout le temps  
par tous les temps !*

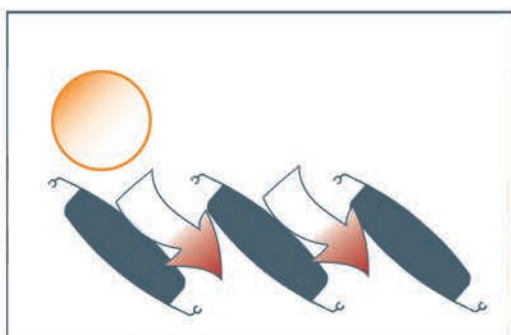

**Par temps frais,  
laissez entrer la chaleur**

## Gérer l'ensoleillement

Gérer librement : l'orientation des lames ,  
pour profiter pleinement du soleil  
ou pour créer une zone d'ombrage

Profiter de votre terrasse tout au long de  
l'année, grâce à nos pergolas.

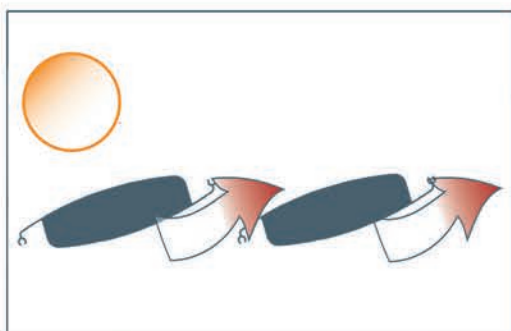

**Evacuez la chaleur,  
pour éviter un effet de serre**

## Ventilation Naturelle

Eviter l'effet de serre, en créant un  
mouvement d'air naturel.

L'air chaud s'évacue par l'ouverture des  
lames et permet une ventilation efficace

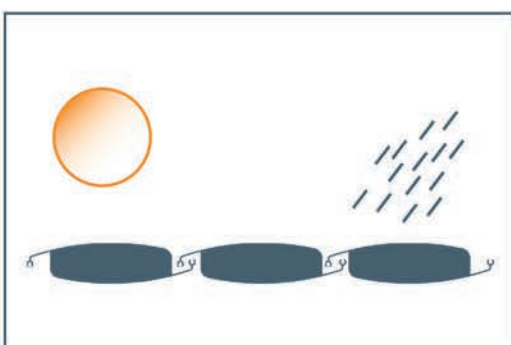

**Protection contre la pluie  
et les rayons du soleil**

## Protection contre la pluie et les rayons du soleil.

Lorsque les lames sont fermées,  
nos pergolas sont étanches de lames à lames  
et vous protègent efficacement contre  
les intempéries.

L'évacuation de l'eau se fait par les  
gouttières puis par les poteaux.











## Pergola B é l i z e

*Le Bioclimatique simplement*



Protection contre les rayons  
du soleil et la pluie



Par temps frais,  
Laissez entrer la chaleur



Evacuez la chaleur,  
pour éviter un effet de serre

## Manoeuvre des lames

Par manivelle Magnétique



## D i m e n s i o n s

3,08x3,08 mètres / 3,98x3,08 mètres / 5,78x3,08 mètres  
(Murale ou Autoportante)

Sur mesure

NOUVEAUTE  
2018

## C o l o r i s s t a n d a r d s

Structure:  Blanc 9010 mat

Gris 7016 sablé

Lames:  Blanc 9010 mat

## O p t i o n s



Eclairage par  
bandeau LED

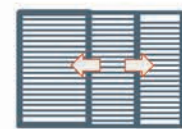

Paroi coulissante  
Brise soleil

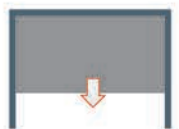

Store non zippé  
enroulable

# DES PROFILS ROBUSTES ET ESTHETIQUES :

Cadre

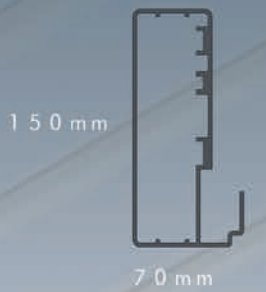

EP. 2,5 mm

Poteau



EP. 4 mm

Lame



EP. 1,5 mm

## FIXATION MURALE

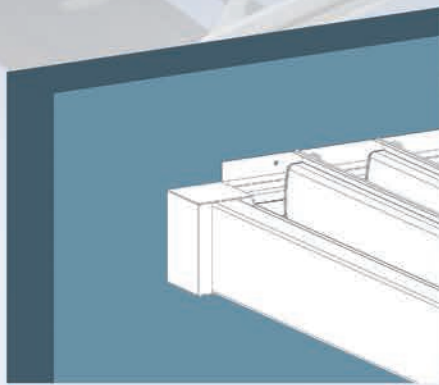

## FIXATION AUTOPORTANTE

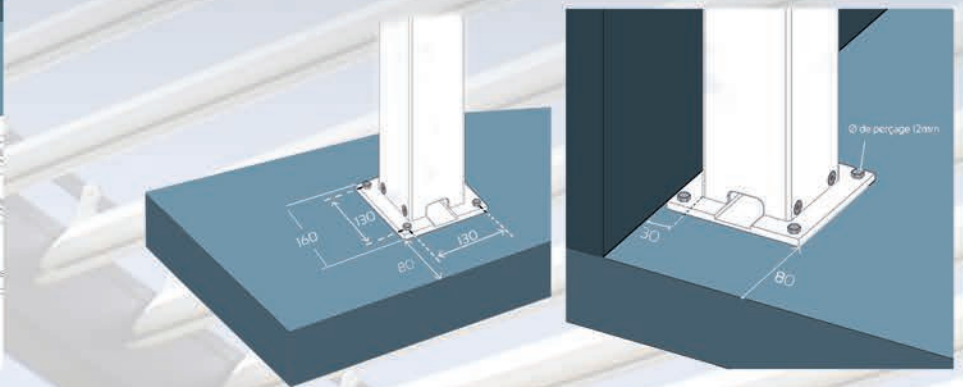

## OPTIONS



Eclairage par bandeau LED (LED)

<b>Structure</b>	Flexible
<b>Puissance</b>	14,4 Watts / mètre
<b>Indice de protection</b>	IP67
<b>Tension</b>	230v/ 24v ---
<b>Puissance lumineuse</b>	900Lm / mètre

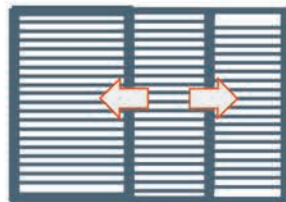

Paroi coulissante  
Brise soleil

<b>Nombre de lame :</b>	40
<b>Section de la lame :</b>	50x10mm
<b>Disponible uniquement en</b>	hauteur standard

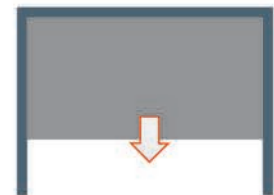

Store non  
zippé enroulable

<b>Grammage de la toile</b>	380g/m <sup>2</sup>
<b>Epaisseur</b>	0,45mm
<b>Température</b>	-30°C / + 70°C

La toile s'enroule dans un carter fixé sur le cadre de la pergola. La manoeuvre se fait avec une manivelle magnétique



# EXEMPLES DE CONFIGURATIONS :



3,08 x 3,08m  
Autoportante



3,98 x 3,08m  
Autoportante

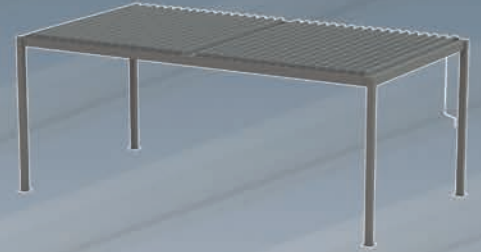

5,78 x 3,08m  
Autoportante



3,08 x 3,08m  
Murale

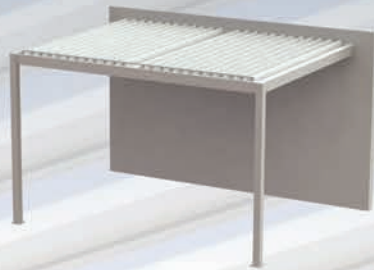

3,98 x 3,08m  
Murale



5,78 x 3,08m  
Murale

## NOS REALISATIONS

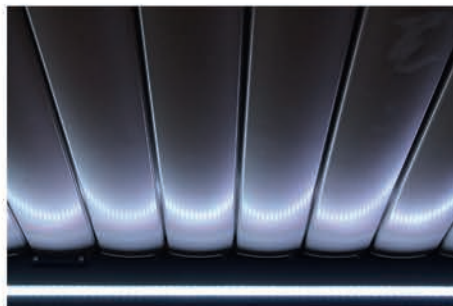







# Pergola Panama

*Le Bioclimatique haut de gamme*



Protection contre les rayons du soleil et la pluie



Par temps frais, Laissez entrer la chaleur



Evacuez la chaleur, pour éviter un effet de serre

## Manoeuvre des lames

Par vérin électrique et télécommande

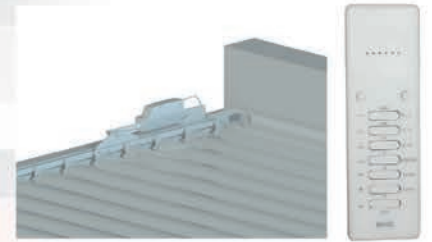

## Dimensions

3x3 mètres / 4,05x3 mètres / 6x3 mètres et **sur mesure** (Murale ou Autoportante)

## Coloris standards

Structure:	<input type="checkbox"/> Blanc 9010 mat	<input type="checkbox"/> Gris 7016 sablé
Lames:	<input type="checkbox"/> Blanc 9010 mat	<input type="checkbox"/> Sur mesure

## Options



Eclairage par bandeau LED

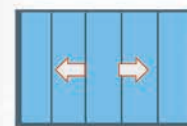

Paroi coulissante verre

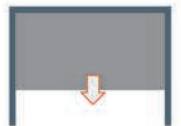

Store zippé enroutable



Capteur vent/pluie/neige/gel



Smart control



# DES PROFILS ROBUSTES ET ESTHÉTIQUES :

Cadre

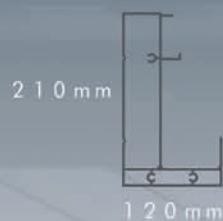

EP. 2,5 mm

Poteau



EP. 5 mm

Closoir poteau



EP. 1,5 mm

Lame

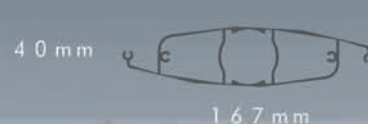

EP. 1,5 mm

Nous assurons l'étanchéité entre lames à l'aide de deux joints (epdm) Une légère pente assure l'évacuation de l'eau vers les poteaux

## FIXATION MURALE

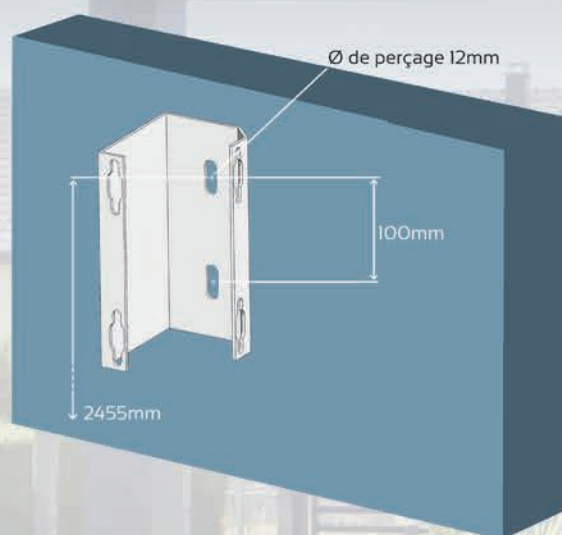

## FIXATION AUTOPORTANTE

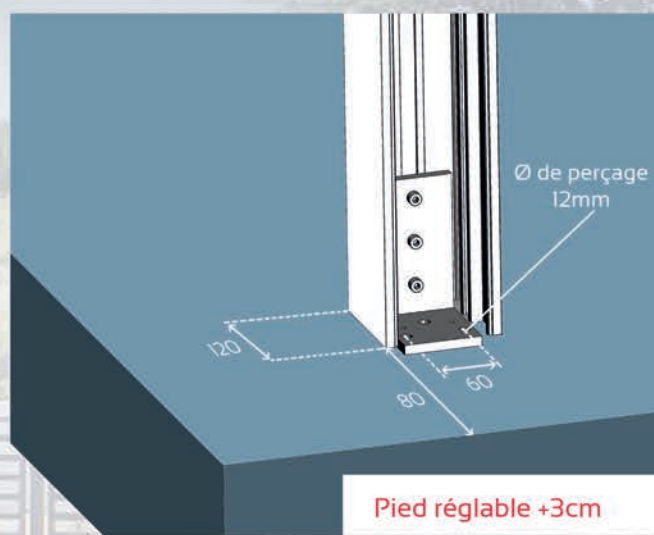

## OPTIONS



Eclairage par bandeau LED

Structure	Flexible
Puissance	14,4 Watts / mètre
Indice de protection	IP67
Tension	230v/ 24v
Puissance lumineuse	900Lm / mètre

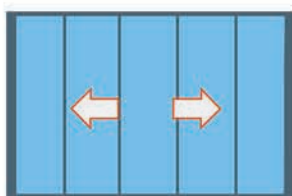

Paroi coulissante verre

Verre trempé de 10 mm
5 parois coulissante

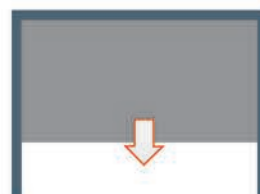

Store zippé enroulable

Grammage de la toile	380g/m <sup>2</sup>
Épaisseur	0,45mm
Température	-30°C / + 70°C
La toile s'enroule dans un carter fixé sur le cadre de la pergola. La manoeuvre se fait avec la même télécommande que la pergola.	



Capteur météo Vent / Pluie neige/gel



Smart control



# EXEMPLES DE CONFIGURATIONS :



3 x 3 m  
Autoportante



4,05 x 3 m  
Autoportante

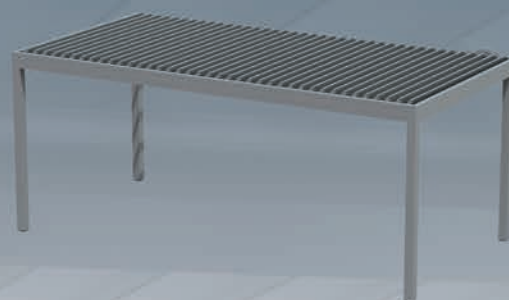

6 x 3 m  
Autoportante

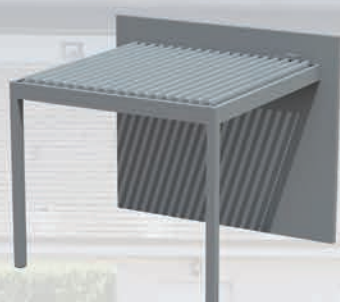

3 x 3 m  
Murale

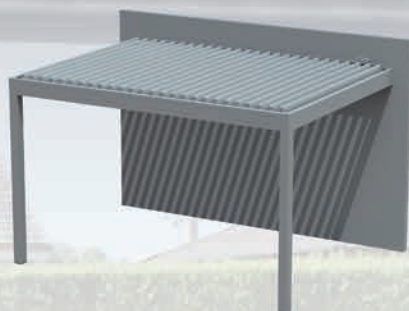

4,05 x 3 m  
Murale

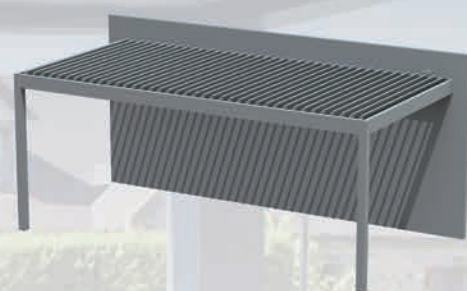

6 x 3 m  
Murale

# EXEMPLES D'ASSEMBLAGES

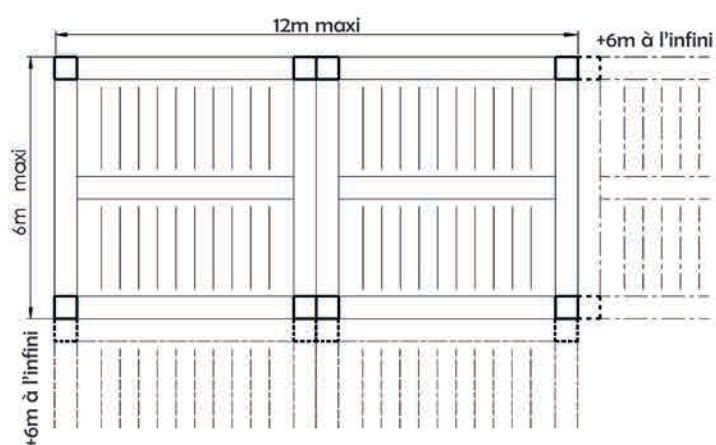
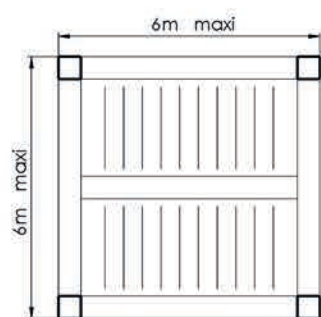
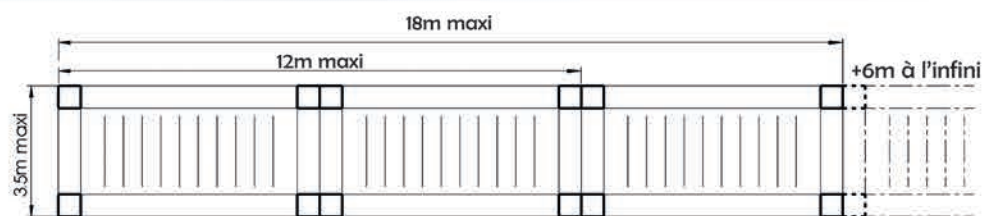
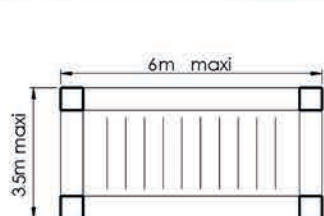



# QUELQUES REALISATIONS





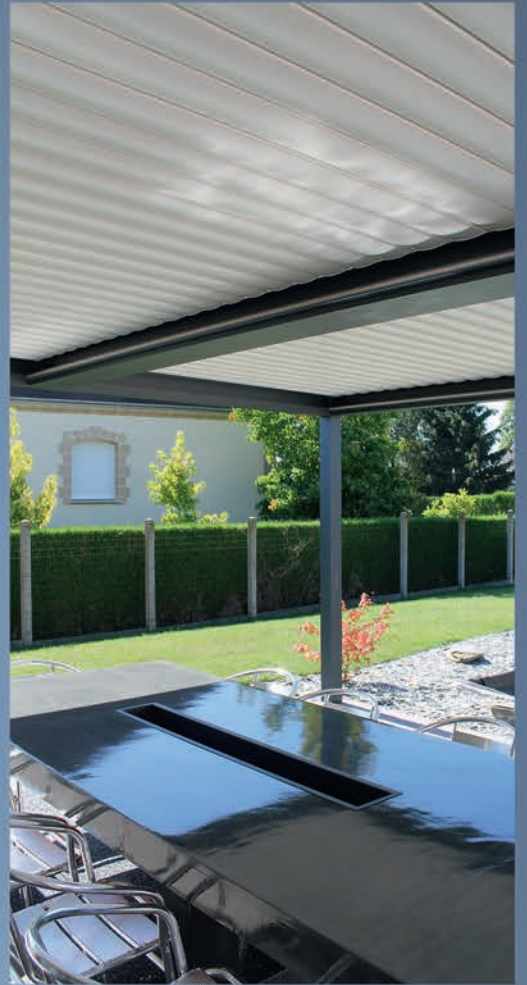





**NOUVEAUTE  
2018**



# Pergola Castille

*Pergola à toit fixe*



Polycarbonate  
alvéolaire opaque 16mm

ou



Panneaux isolés  
blanc 16mm

## Dimensions

3,71x3 mètres / 4,92x3,08 mètres / 6,13x3,08 mètres  
(Murale ou Autoportante)

## Coloris standards

Structure:



Blanc 9010 mat



Gris 7016 sablé

## Options



Eclairage par  
bandeau LED

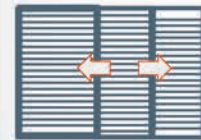

Paroi coulissante  
Brise soleil



Store **non zippé**  
enroulable



# DES PROFILS ROBUSTES ET ESTHETIQUES :

## Cadre

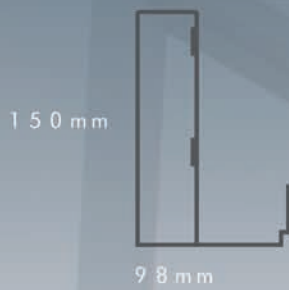

EP. 2,5 mm

## Poteau



EP. 4 mm

## Coiffe+2 joints



EP. 1,5 mm

## Panne



60 mm

60 mm

## FIXATION MURALE

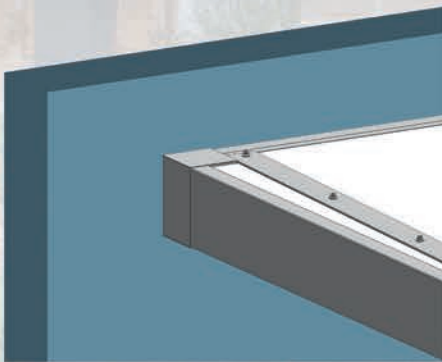

## FIXATION AUTOPORTANTE

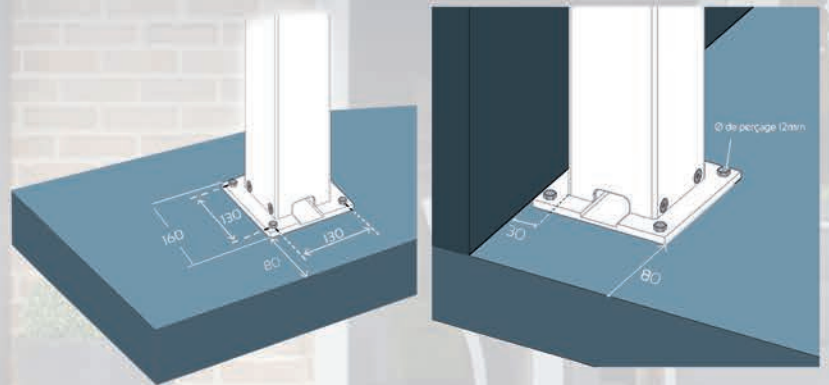

## OPTIONS



Eclairage par bandeau LED (LED)

<b>Structure</b>	Flexible
<b>Puissance</b>	14,4 Watts / mètre
<b>Indice de protection</b>	IP67
<b>Tension</b>	230v/ 24v ---
<b>Puissance lumineuse</b>	900Lm / mètre

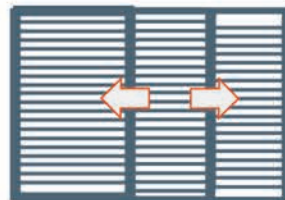

Paroi coulissante  
Brise soleil

<b>Nombre de lame :</b>	40
<b>Section de la lame :</b>	50x10mm
<b>Disponible uniquement en</b>	hauteur standard

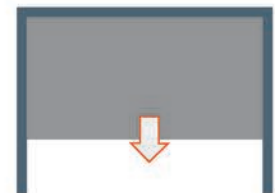

Store non zippé  
enroulable

<b>Grammage de la toile</b>	380g/m <sup>2</sup>
<b>Epaisseur</b>	0,45mm
<b>Température</b>	-30°C / + 70°C

*La toile s'enroule dans un carter fixé sur le cadre de la pergola. La manoeuvre se fait avec une manivelle magnétique*



# EXEMPLES DE CONFIGURATIONS :



3,71 x 3,08m  
Autoportante



4,92 x 3,08m  
Autoportante

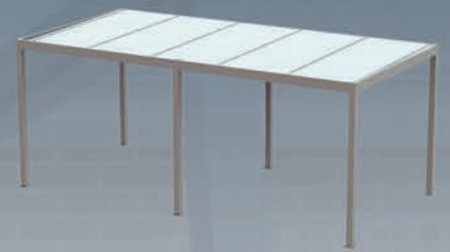

6,13 x 3,08m  
Autoportante



3,71 x 3,08m  
Murale



4,92 x 3,08m  
Murale



6,13 x 3,08m  
Murale

## NOS REALISATIONS





Tél : 03.23.91.35.63  
 Fax : 03.23.98.04.42  
 Mail : devis@orialpro.fr

### PERGOLA 'BELIZE'

MODÈLE EN ALUMINIUM A LAMES ORIENTABLES 'BIOCLIMATIQUE'

Entreprise : .....

Adresse : .....

Ville : ..... CP : .....

Tél : ..... Fax : .....

Mail : .....@.....

Tampon : .....





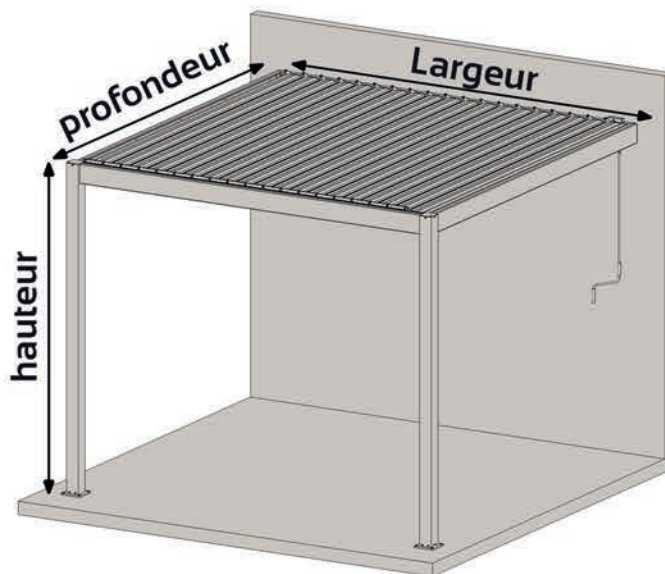

Personne en charge du dossier : .....

Référence du chantier : .....

Pour info. : ht standard hors tout  
2610mm



Pour information : commande d'ouverture des lames par manivelle

AUTOPORTANTE	MURALE	OPTIONS
 <input type="checkbox"/> Dim. 3,08 x 3,08 x ht 2,5	 <input type="checkbox"/> Dim. 3,08 x 3,08 x ht 2,5	<input type="checkbox"/> Option éclairage (Leds blanches, 2 bandeaux) <input type="checkbox"/> Store non zippé manuel <input type="checkbox"/> Paroi coulissante Brise soleil
 <input type="checkbox"/> Dim. 3,98 x 3,08 x ht 2,5	 <input type="checkbox"/> Dim. 3,98 x 3,08 x ht 2,5	
 <input type="checkbox"/> Dim. 5,78 x 3,08 x ht 2,5	 <input type="checkbox"/> Dim. 5,78 x 3,08 x ht 2,5	

○ **Couleur :**     BLANC RAL 9010 MAT                       GRIS RAL 7016 SABLÉ

**Configuration chantier :**



Tél : 03.23.91.35.63  
 Fax : 03.23.98.04.42  
 Mail : devis@orialpro.fr



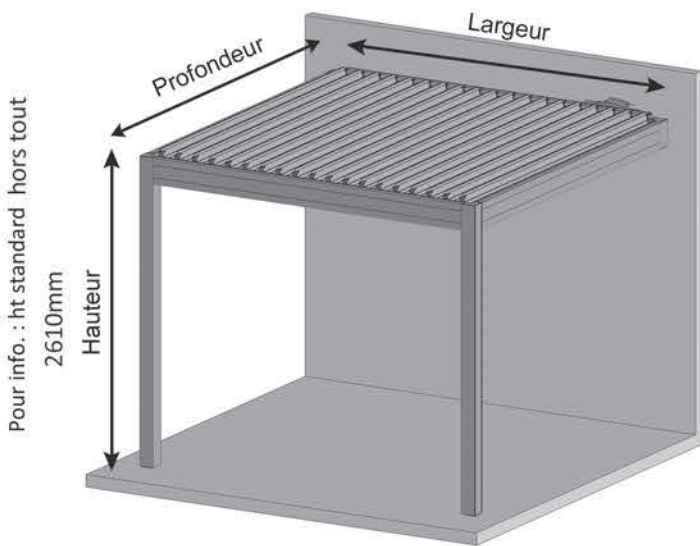

### PERGOLA 'PANAMA'

MODELE EN ALUMINIUM A LAMES ORIENTABLES 'BIOCLIMATIQUE'

Entreprise :  
 .....  
 Adresse : .....  
 Ville : ..... CP : .....  
 Tél : ..... Fax : .....  
 Mail :  
 .....@.....  
 Tampon :  
  
 Personne en charge du dossier : .....  
 Référence du chantier : .....

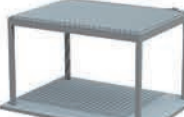

Pour information: commande d'ouverture des lames motorisée

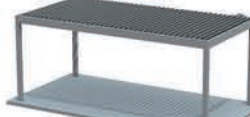
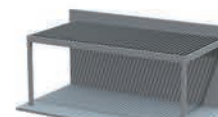
AUTOPORTANTE	MURALE	OPTION
 <input type="checkbox"/> Dim. 3 x 3 x ht 2,5	 <input type="checkbox"/> Dim. 3 x 3 x ht 2,5	<input type="checkbox"/> Option éclairage (Leds RVB, 2 bandeaux) <input type="checkbox"/> Store zippé motorisé <input type="checkbox"/> Paroi vitrée coulissante <input type="checkbox"/> Capteur météo (Vent / pluie /neige/ gel) <input type="checkbox"/> Smart control
 <input type="checkbox"/> Dim. 4.05 x 3 x ht 2,5	 <input type="checkbox"/> Dim. 4,05 x 3 x ht 2,5	
 <input type="checkbox"/> Dim. 6 x 3 x ht 2,5	 <input type="checkbox"/> Dim. 6 x 3 x ht 2,5	

○ **Couleur :**     BLANC RAL 9010 MAT                       GRIS RAL 7016 SABLÉ

**Configuration chantier :**



Tél : 03.23.91.35.63  
 Fax : 03.23.98.04.42  
 Mail : devis@orialpro.fr

### PERGOLA 'CASTILLE'

MODELE EN ALUMINIUM TOITURE TERRASSE

Entreprise : .....

Adresse : .....

Ville : ..... CP : .....

Tél : ..... Fax : .....

Mail : .....@.....

Tampon : .....







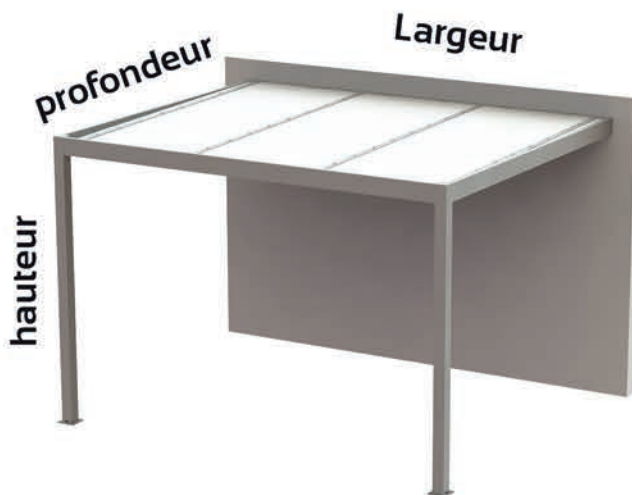

Personne en charge du dossier : .....

Référence du chantier : .....

Pour info. : ht standard hors tout  
2512mm



AUTOPORTANTE	MURALE	OPTIONS
 <input type="checkbox"/> Dim. 3,71 x 3,08 x ht 2,5	 <input type="checkbox"/> Dim. 3,71 x 3,08 x ht 2,5	<input type="checkbox"/> Option éclairage(Leds blanches, 1 bandeaux) <input type="checkbox"/> Store non zippé manuel <input type="checkbox"/> Paroi coulissante Brise soleil
 <input type="checkbox"/> Dim. 4,92 x 3,08 x ht 2,5	 <input type="checkbox"/> Dim. 4,92 x 3,08 x ht 2,5	
 <input type="checkbox"/> Dim. 6,13 x 3,08 x ht 2,5	 <input type="checkbox"/> Dim. 6,13 x 3,08 x ht 2,5	

○ **Couleur :**     BLANC RAL 9010 MAT                       GRIS RAL 7016 SABLÉ

**Configuration chantier :**



# Tableau de synthèse pergola

	Pergola Bélize	Pergola Panama	Pergola Castille
Livraison domicile	●	●	●
Toiture			
Polycarbonate alvéolaire opaque			●
Panneaux isolés blanc			●
Lames			
Orientations des lames	●	●	
Manoeuvre des lames	manuelle	motorisée	
Version de pose			
Murale	●	●	●
Autoportante	●	●	●
Dimensions			
3x3 <sup>di</sup>	●	●	
4x3*	●	●	
6x3*	●	●	
3,71 x 3,08*			●
4,92 x 3,08*			●
6,13 x 3,08*			●
Sur mesure	●	●	
Coloris Structure			
Gris 7016 sablé	●	●	●
Blanc 9010 mat	●	●	●
Sur mesure		●	
Coloris lames			
Blanc 9010 mat	●	●	
Sur mesure		●	
En Options			
Store non zip	●		●
Store zip		●	
Eclairage LED (2 bandeaux)	● Blanc	● RGB	
Eclairage LED (1 bandeaux)			● Blanc
Paroi coulissante verre		●	
Smart control		●	
Capteur Météo (vent, pluie, neige, gel)		●	
Paroi coulissante brise soleil	●		●

\* Se référer aux fiches produits pour des dimensions plus précises



Obtenez votre devis et vo  
grâce à notre confi

[www.oria](http://www.oria)

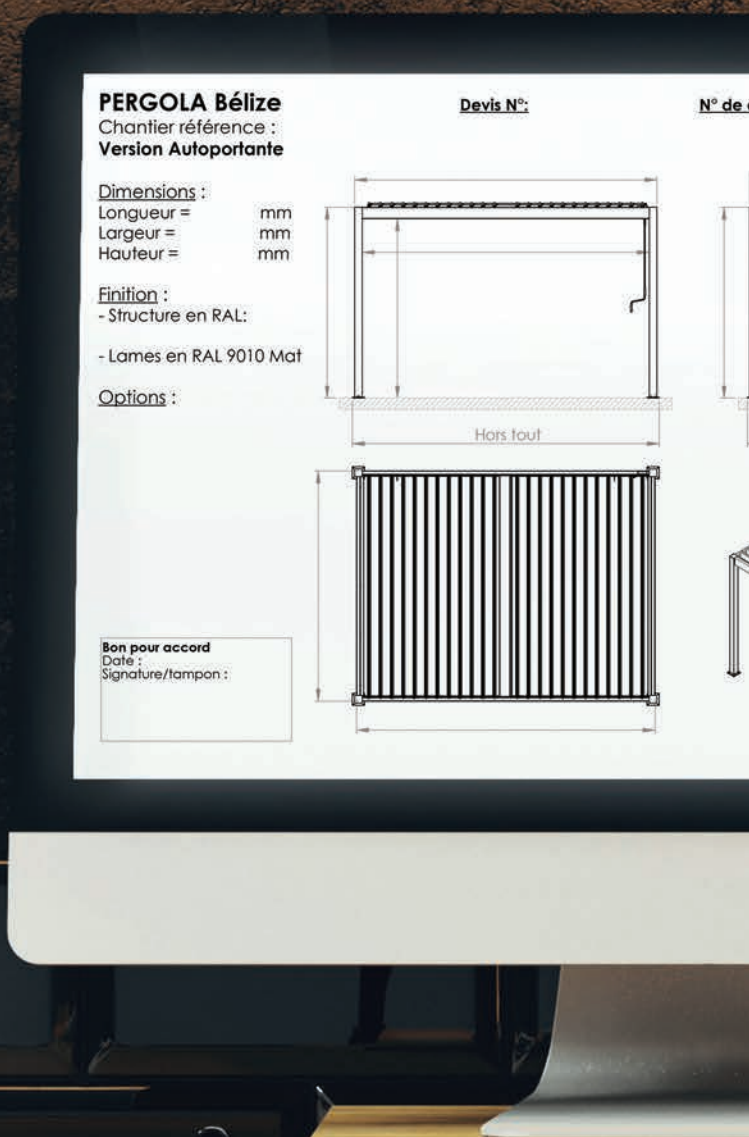



otre plan très rapidement  
figurateur en ligne

[riasun.fr](http://riasun.fr)





NOTRE GAMME DE CARPORT

**Abritez vos véhicules  
grâce à nos carports  
aluminium**













## Carport C150

Choisissez votre toiture :

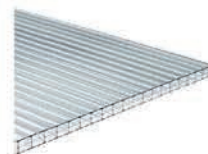

Polycarbonate  
alvéolaire opaque 16mm

**ou**



Panneaux isolés  
blanc 16mm

## Dimensions

4,92 x 3,08 mètres / 6,13 x 3,08 mètres  
(Murale ou Autoportante)

**Pas de sur mesure**

## Coloris standards

Structure:  Blanc 9010 mat

 Gris 7016 sablé



# DES PROFILS ROBUSTES ET ESTHETIQUES :

Cadre

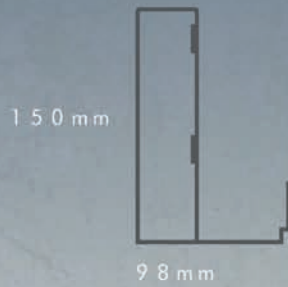

EP. 2,5 mm

Poteau



EP. 4 mm

Coiffe+2 joints

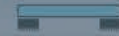

Panne



EP. 1,5 mm

## FIXATION MURALE

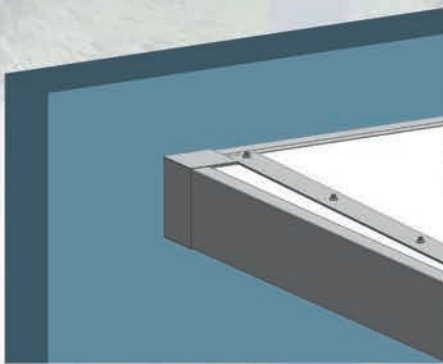

## FIXATION AUTOPORTANTE

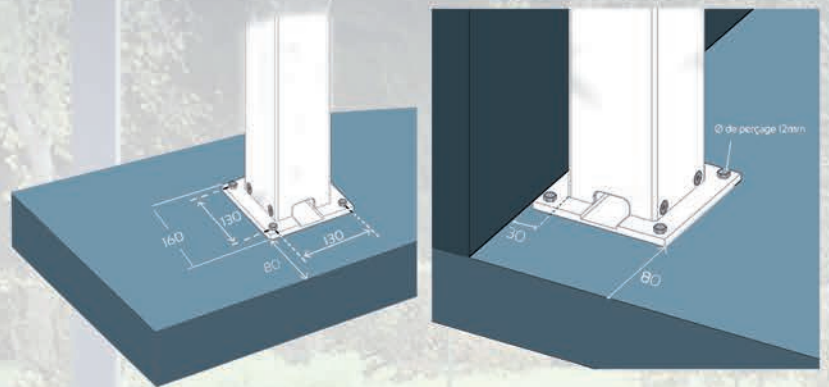

## OPTIONS



Eclairage par bandeau LED  
(1 bandeau)

<b>Structure</b>	Flexible
<b>Puissance</b>	14,4 Watts / mètre
<b>Indice de protection</b>	IP67
<b>Tension</b>	230v/ 24v $\overline{\text{---}}$
<b>Puissance lumineuse</b>	900Lm / mètre

# EXEMPLES DE CONFIGURATIONS :



4,92 x 3,08m  
Autoportante



6,13 x 3,08m  
Autoportante



4,92 x 3,08m  
Autoportante



6,13 x 3,08m  
Autoportante

## NOS REALISATIONS









# Carport C210

Choisissez votre toiture :

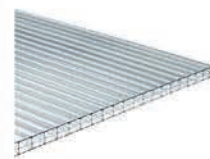

Polycarbonate  
alvéolaire opaque 16mm

**ou**



Panneaux isolés  
blanc 16mm

## Dimensions

5,15 x 3 mètres / 6,36 x 3 mètres

(Murale ou Autoportante)

**Sur mesure possible**

## Coloris standards

Structure:  Blanc 9010 mat

Gris 7016 sablé

## Options



Eclairage par  
bandeau LED

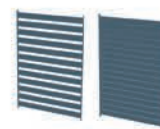

Paroi ajourée  
/ non ajourée



# DES PROFILS ROBUSTES ET ESTHETIQUES :

Cadre

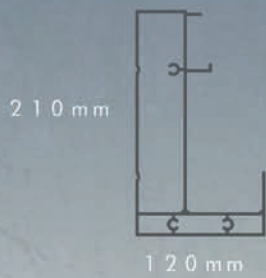

EP. 2,5 mm

Poteau

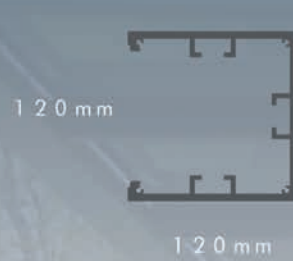

EP. 5 mm

Coiffe+2 joints



EP. 1,5 mm

## FIXATION MURALE

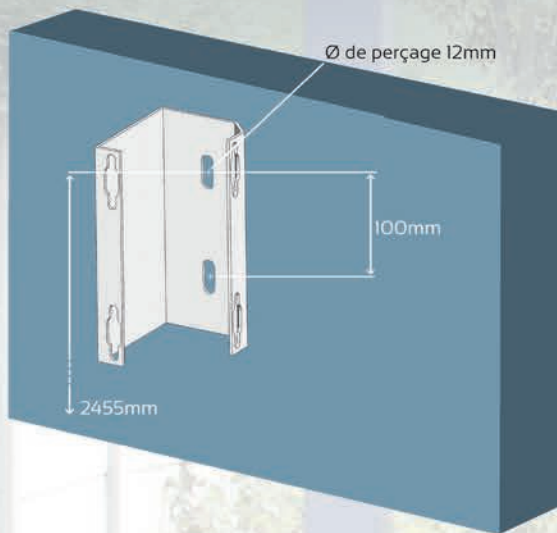

## FIXATION AUTOPORTANTE

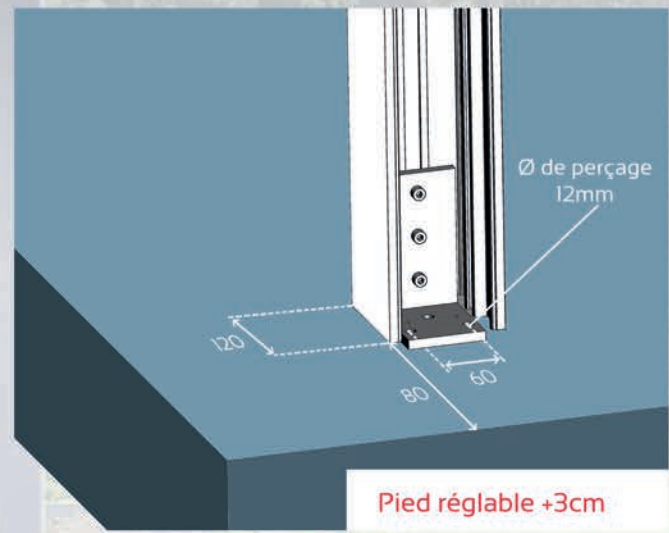

## OPTIONS



Eclairage par spot + détecteur de présence

<b>Qté:</b>	10 spots par bandeau
<b>Puissance</b>	0,3 Watts / spot
<b>Indice de protection</b>	IP67
<b>Tension</b> 	230v/ 12v

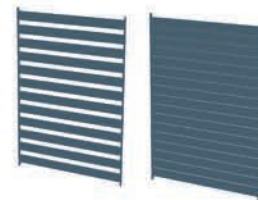

Paroi ajourée et non ajourée



# EXEMPLES DE CONFIGURATIONS :



5,15 x 3m  
Autoportante



6,36 x 3m  
Autoportante

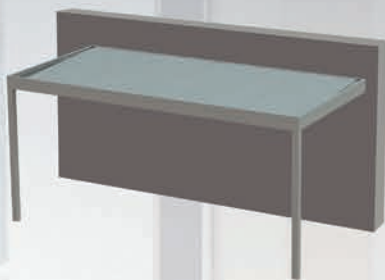

5,15 x 3m  
Murale



6,36 x 3m  
Murale

## EXEMPLES



Paroi latérale



Paroi arrière



Paroi latérale + arrière



# Tableau de synthèse carport

	Carport C-150	Carport C-210
Livraison domicile	●	●
<b>Toiture</b>		
Polycarbonate alvéolaire opaque	●	●
Panneaux isolés blanc	●	●
<b>Version de pose</b>		
Murale	●	●
Autoportante	●	●
<b>Dimensions</b>		
4,92 x 3,08 mètres	●	
6,13 x 3,08 mètres	●	
5,15 x 3 mètres		●
6,36 x 3 mètres		●
Sur mesure		●
<b>Coloris Structure</b>		
Gris 7016 sablé	●	●
Blanc 9010 mat	●	●
<b>En Options</b>		
Eclairage bandeau LED Blanc	●	
Eclairage Spot avec detecteur de présence		●
Paroi ajourée / non ajourée		●

\* Se référer aux fiches produits pour des dimensions plus précises





Retrouver les présentations et vidéos de montages de nos produits sur notre chaîne youtube : Oriasun

## Chiffrez directement votre chantier



**Si vous n'avez pas encore accès à notre bibliothèque faites en la demande**







## Brise soleil

## Dimensions

1420 x 768 mm ou 2860 x 768mm en standard  
et sur mesure possible



Longueur sur mesure possible à l'infini  
en assemblant les modules

## Coloris standards

Structure:  Gris 7016 sablé

 Sur mesure

## Caractéristiques :

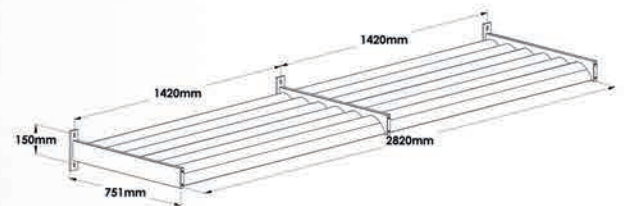
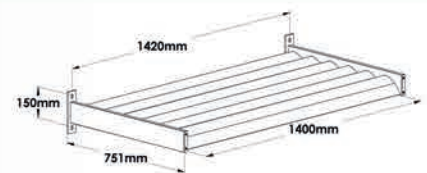

## Nos réalisations

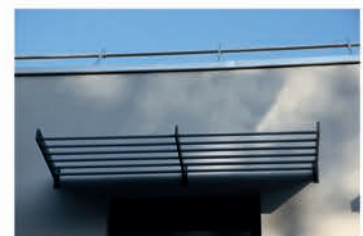

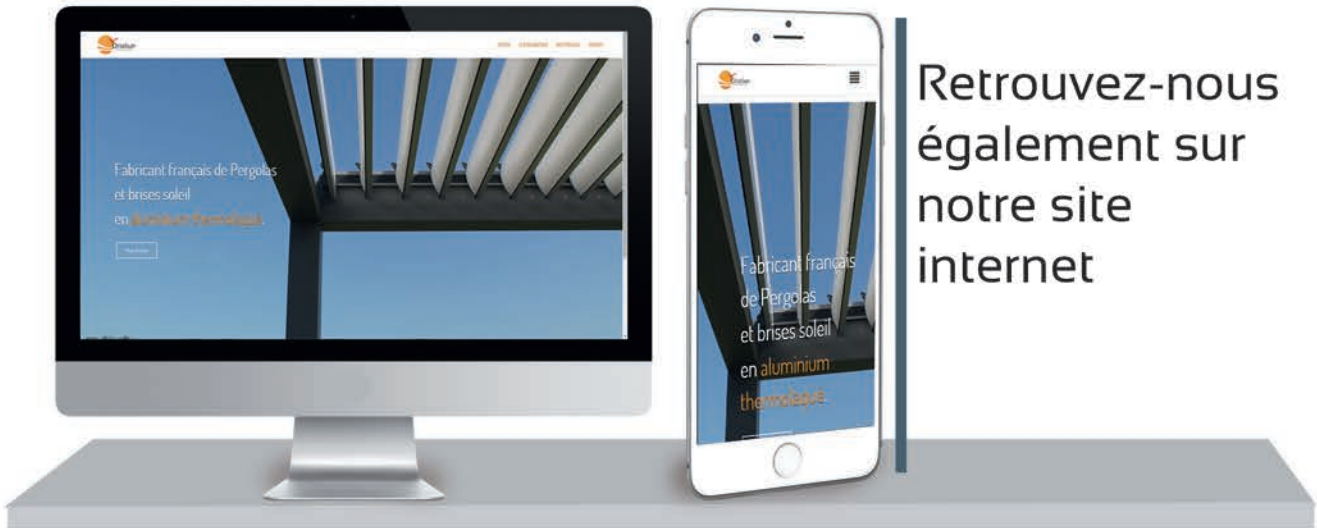

Retrouvez-nous également sur notre site internet

[www.oriasun.fr](http://www.oriasun.fr)

Documentations

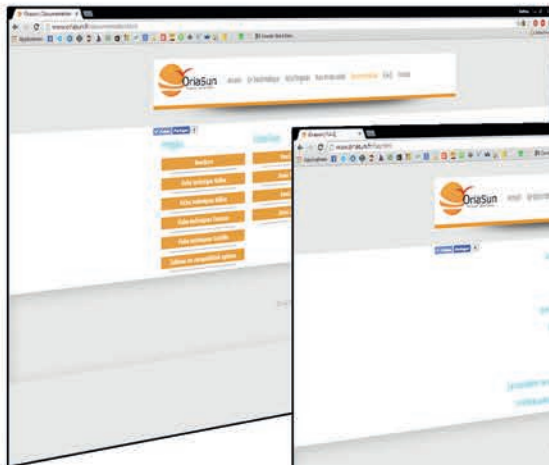

F.A.Q

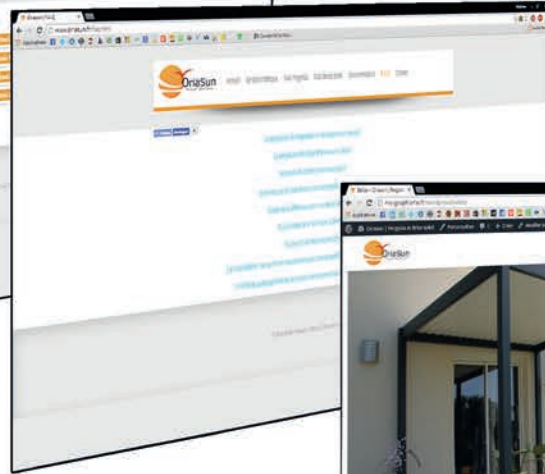

Fiches Techniques

